



# LED INGROUND LUMINAIRE

## PRODUCT INFORMATION

- The Illus LED inground lights provide significant benefits, including exceptional energy efficiency and reduced electricity costs.
- These lights are more durable and eco-friendlier than traditional options, offering a cost-effective, low-maintenance solution to beautifully illuminate landscapes and architectural features."
- Our LED inground lights has the rating power of 2.5W that is perfectly suit to your garden's style and lighting needs.

## BENEFITS

- LEDs use up to 80% less energy than incandescent bulbs, last much longer, produce less heat, and cut both electricity bills and carbon emissions.
- Provide bright, durable outdoor lighting for pathways, driveways, and pool areas, ensuring safe navigation for pedestrians and vehicles at night.
- Highly durable outdoor lighting, more resistant to shock, vibration, dust, and wind than older technologies, making it ideal for harsh outdoor conditions.
- Energy-efficient lighting that produces less heat and contains no mercury, offering a greener, eco - friendly choice with reduced long-term landfill impact.

## FEATURES

- Flicker Free.
- High CRI $\geq$ 90.
- Energy Saving.
- IK Rating IK08.
- Non-Dimmable.
- Surge Protection 1kV.
- Long Lifespan 30000H.



**BEYOND LIGHT..  
TO THE LAST DETAILS!**

## AREAS OF APPLICATION



Hospitality



Shopping Center



Commercial



Educational Center

## TECHNICAL OPERATING & ELECTRICAL DATA

Body Color	Silver
Rated Power	2.5W
CCT	3000K
CRI	≥90
Voltage and Frequency	AC220-240V, 50/60Hz
Ambient Temperature	-30°C~45°C
IP Rating	IP67
IK Rating	IK08
IEC Classification	Class I
Dimming	Non Dimmable
Surge Protection	1kV
Lifespan	30,000H
Switching Cycle	100,000x on/off
Warranty Period	36 Months

## SPECIFICATIONS

Code No.	Model No.	Lumen	Efficacy	Beam Angle	P.F	Cutting Size	Current
LI521334	ILS2.5RMOIGL01	160lm	64lm/W	30°	0.36	D46mm	30mA
LI521335	ILS2.5RMOIGL10	110lm	44lm/W	70°	0.36	D46mm	30mA

## DIMENSIONS

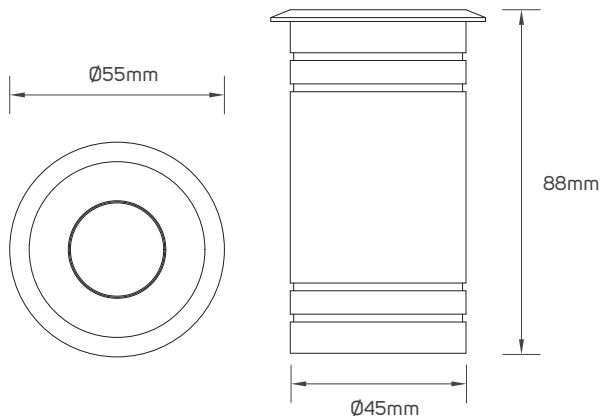

## ACCESSORIES SPECIFICATIONS

Code No.	Model No.	Body Color
LI521336	ILRMOFR01	Silver
LI521337	ILRMOFR02	Silver
LI521338	ILRMOFR03	Silver

## ACCESSORIES DIMENSIONS

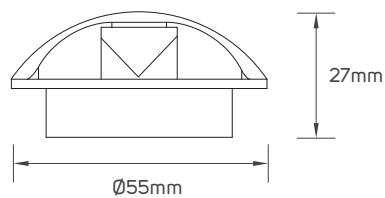
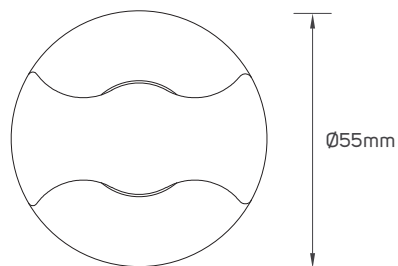
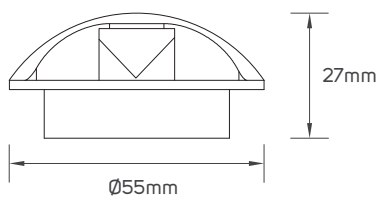
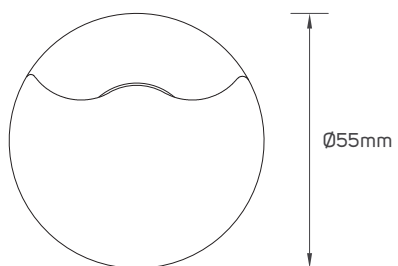

LI521336

LI521337

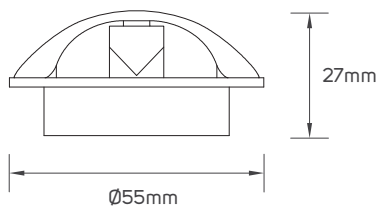
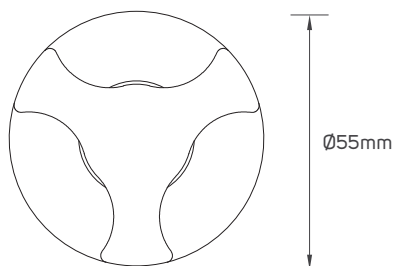

LI521338

## APPLICATION PICTURE



This image is for display purpose only, the image may differ from the actual product, as the product is subject to modification provided without prior notice.

## LED INGROUND LUMINAIRE

**BEYOND LIGHT..  
TO THE LAST DETAILS!**



build-station



lighting stores



illus lighting

C/ Cuenca, 87, Alaquas 46970, (Valencia) Spain, Ph. 34 961 623 958

[www.illusillumination.com](http://www.illusillumination.com)

illus illumination reserve the right to make dimensional, design and technical alternations without prior notice. illus illumination endeavor to ensure that any advice, recommendation or information it provides in product literature is accurate and correct. However due to the fact that illus do not have direct control on where and how the products are installed, illus illumination cannot accept any liability either direct or indirect arising from the use of illus products whether or not in accordance with any advice, specification, recommendation or information provided by illus illumination or its distributors.