



LED PRO

Simple & Flexible Solution

LED FLEXIBLE LINEAR LIGHT

PRODUCT INFORMATION

- Excellently anti-dust LED strips with professional design to guarantee lighting performance.
- It not only ensure high quality of lighting color consistency but also protect products against from harsh environments.

BENEFITS

- Vivid light color.
- Less maintenance cost and less concerns.

FEATURES

- High CRI>92.
- Operating voltage DC24V.

AREAS OF APPLICATION



Hospitality



Shopping Center



Commercial



Educational Center

TECHNICAL OPERATING & ELECTRICAL DATA

LED Quantity	120pcs/meter
Input	DC24V
Maximum Length	5M/Reel
Cutting Unit	50mm
Size	10x10mm
Packging	Male & female DC connector, 5m/reel into a anti-static bag, 20 bags into a master carton

SPECIFICATIONS

Code No.	Model No.	IP	Power	CCT
611917	ILS09LVNFRGB01	65	9W/M	RGB

DIMENSIONS

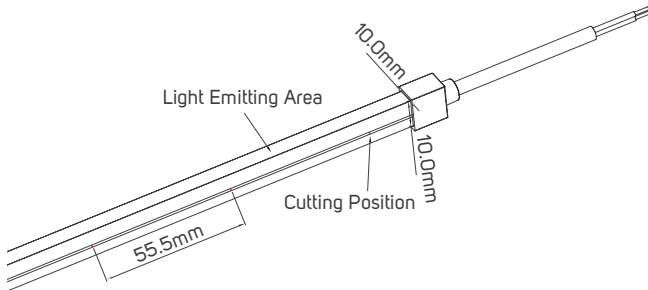

611917

ACCESSORIES

LED FLEXIBLE LINEAR LIGHT CONNECTOR
AVAILABLE AS AN ACCESSORY

Code No.	Model No.	IP	Power	Input	Output	Frequency	Dimensions
611961	ILSLVNFALMFCH07						10.8x30x10.8mm
611954	ILSLVNFALMFCH03						11.7x1000x12.2mm
611969	ILSLVNFALMFCH15						10.8x308x11.1mm
611970	ILSLVNFALMFCH16						10.8x596x11.1mm
611971	ILSLVNFALMFCH17						10.8x886x11.1mm
611984	ILSLVNF2HFC01						L=300mm
611948	ILS75W24VCG01	20	75W	AC220-240V	DC24V	50/60Hz	78x110x36mm
611949	ILS100W24VCG01	20	100W	AC220-240V	DC24V	50/60Hz	98x130x41mm
611950	ILS150W24VCG01	20	150W	AC220-240V	DC24V	50/60Hz	98x160x50mm

ACCESSORIES DIMENSIONS

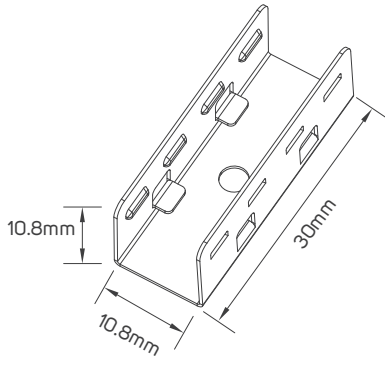

611961

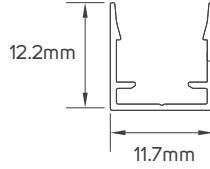

611954

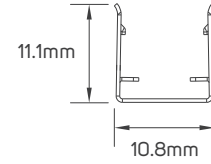

611969 - 611970 - 611971

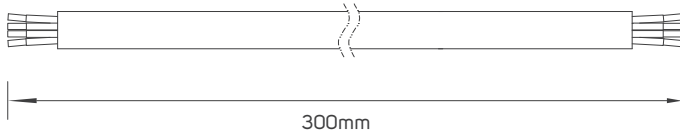

611984

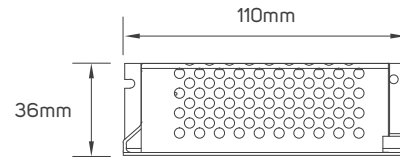

611948

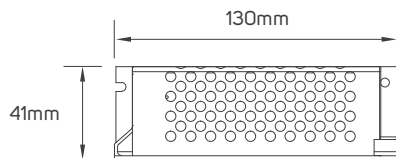
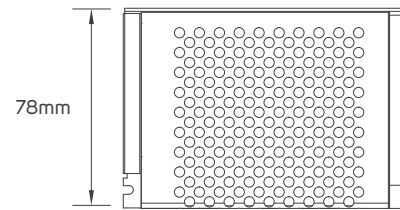

98mm

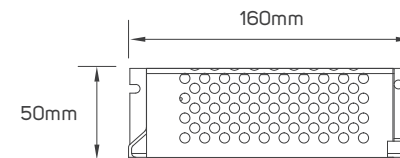

98mm

611949

611950

APPLICATION PICTURE

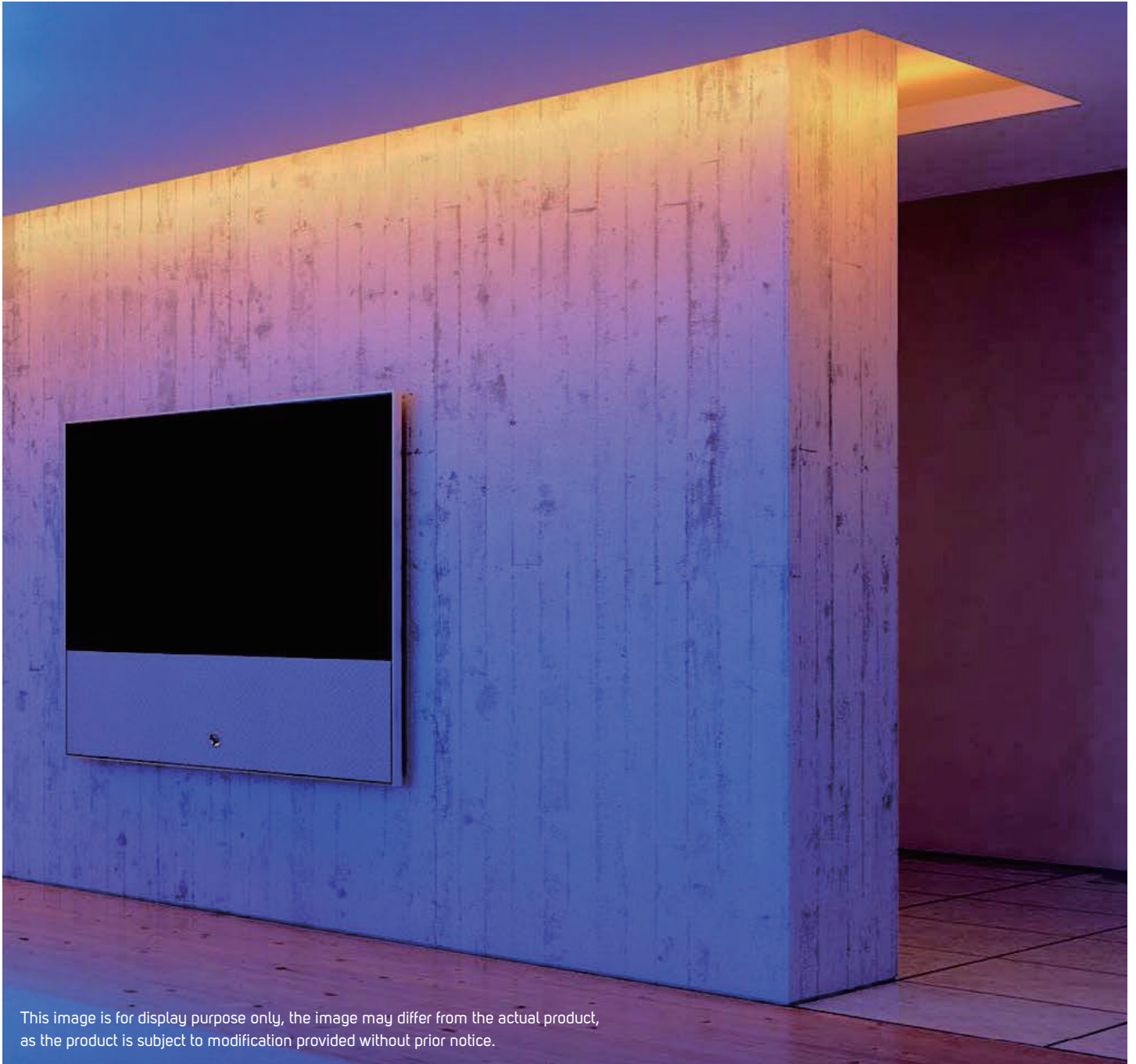

This image is for display purpose only, the image may differ from the actual product, as the product is subject to modification provided without prior notice.

LED FLEXIBLE LINEAR LIGHT

**BEYOND LIGHT..
TO THE LAST DETAILS!**



Carrer de la Vall de la Ballestera, 64, 46015 València, Valencia, España, Tel: +34619824456

www.illusillumination.com

illus illumination reserve the right to make dimensional, design and technical alternations without prior notice. illus illumination endeavor to ensure that any advice, recommendation or information it provides in product literature is accurate and correct. However due to the fact that illus do not have direct control on where and how the products are installed, illus illumination cannot accept any liability either direct or indirect arising from the use of illus products whether or not in accordance with any advice, specification, recommendation or information provided by illus illumination or its distributors.