

Great energy efficient LED Panel

LED FLAT LUMINAIRE SERIES

PRODUCT INFORMATION

- Highly efficient LED panel.
- Very competitive price.
- ILLUS LED FLAT Luminaire gives the customer the flexibility to choose between 6 models based on their specific need with lumen package from 3100 lm to 4400 lm.

BENEFITS

- Great quality and reliability.
- Long lifetime.
- Energy efficient.

FEATURES

- High CRI > 92.
- Efficacy up to 110 lm/w.
- Long life span 50,000hrs.
- Operating voltage AC100–277V.
- Non – dimmable.



**BEYOND LIGHT..
TO THE LAST DETAILS!**

AREAS OF APPLICATION



Hospitality



Public indoor



Shopping Center



Commercial



Work space



Educational center

TECHNICAL OPERATING & ELECTRICAL DATA

Input Voltage & Frequency	AC100-277V, 50/60Hz
Rated CRI	92
Beam Angle	120°
Life Span	50000h
Dimming	Non-Dimmable
IP Rating (Front)	IP40
IP Rating (Back)	IP20
Body Color	White
Body Material	Aluminum
IEC Classification	Class III
Switching Cycle	100000X, on/off
Ambient Temperature	-20°C~45°C

SPECIFICATIONS

Code No.	Model No.	Power	Lumen	Efficacy	CCT	Lamp Type
612651	ILS60FLATL930WW01	40W	4200lm	105lm/w	3000K	Indirect
612652	ILS60FLATL940NW01	40W	4300lm	107.50lm/w	4000K	Indirect
612653	ILS60FLATL957DL01	40W	4400lm	110lm/w	5700K	Indirect
612654	ILS120FLATL930WW01	40W	3100lm	77.50lm/w	3000K	Indirect
612655	ILS120FLATL940NW01	40W	3150lm	78.75lm/w	4000K	Indirect
612656	ILS120FLATL957DL01	40W	3200lm	80lm/w	5700K	Indirect



DIMENSIONS

595mmX595mm

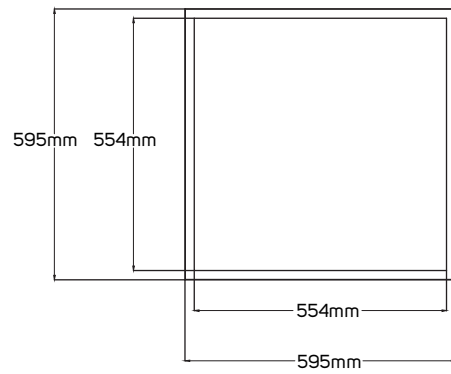
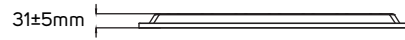
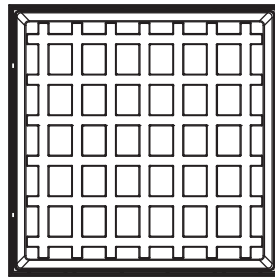

612651, 612652, 612653

295mmX1195mm

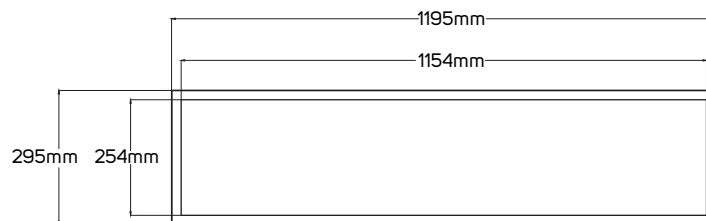
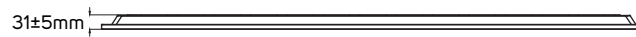
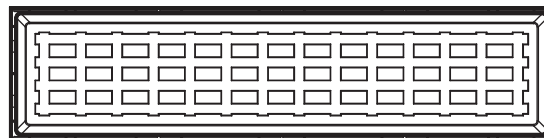

612654, 612655, 612656

ACCESSORIES SPECIFICATIONS

Code No.	Model No.	Body Color
612657	ISD102MBMZK2X2	white
612658	ISD102MBMZK1X4	white
612659	ISD102MBYDS	Metal

ACCESSORIES DIMENSIONS

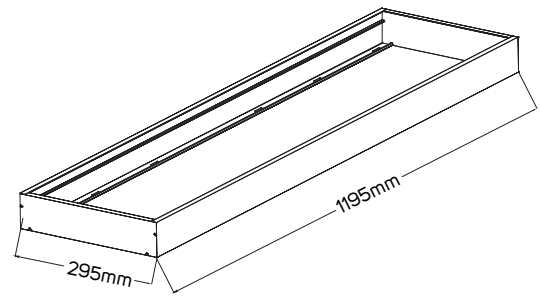
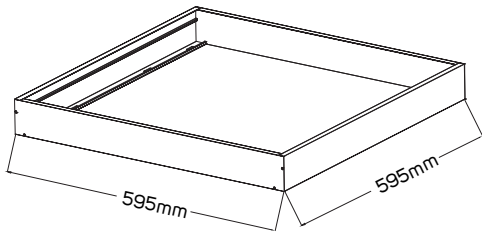

612657

612658

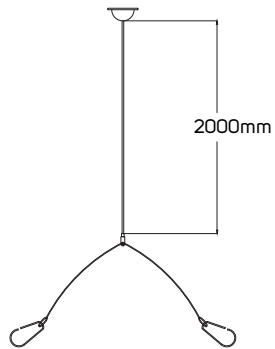

612659

APPLICATION PICTURE



This image is for display purpose only, the image may differ from the actual product, as the product is subject to modification provided without prior notice.

LED FLAT LUMINAIRE SERIES

BEYOND LIGHT..
TO THE LAST DETAILS!

