



LED PRO

LED INGROUND LUMINAIRE

PRODUCT INFORMATION

- The Illus LED inground lights provide significant benefits, including exceptional energy efficiency and reduced electricity costs.
- These lights are more durable and eco-friendlier than traditional options, offering a cost-effective, low-maintenance solution to beautifully illuminate landscapes and architectural features."
- Our LED inground lights has the rating power of 6W and feature interchangeable covers to perfectly suit your garden's style and lighting needs.

BENEFITS

- LEDs use up to 80% less energy than incandescent bulbs, last much longer, produce less heat, and cut both electricity bills and carbon emissions.
- Provide bright, durable outdoor lighting for pathways, driveways, and pool areas, ensuring safe navigation for pedestrians and vehicles at night.
- Highly durable outdoor lighting, more resistant to shock, vibration, dust, and wind than older technologies, making it ideal for harsh outdoor conditions.
- Energy-efficient lighting that produces less heat and contains no mercury, offering a greener, eco-friendly choice with reduced long-term landfill impact.

FEATURES

- Flicker Free.
- High CRI \geq 95.
- Energy Saving.
- IK Rating IK08.
- Non-Dimmable.
- Surge Protection 1kV.
- Long Lifespan 50000H.



**BEYOND LIGHT..
TO THE LAST DETAILS!**

AREAS OF APPLICATION



Hospitality



Shopping Center



Commercial



Educational Center

TECHNICAL OPERATING & ELECTRICAL DATA

CCT	3000K
CRI	≥95
Voltage and Frequency	AC220-240V, 50/60Hz
Ambient Temperature	-20°C~45°C
IP Rating	IP67
IK Rating	IK08
IEC Classification	Class I
Dimming	Non-Dimmable
Surge Protection	1kV
Lifespan	50,000H
Switching Cycle	100,000x on/off
Warrantyn Period	36 Months

SPECIFICATIONS

Code No.	Model No.	Body Color	Body Material	Power	Beam Angle	D.F	P.F	Cutting Size
LI615844	ILS6RMOIGLO4	Black	Aluminum	6W	60°	0.98	0.4	D66mm

DIMENSIONS

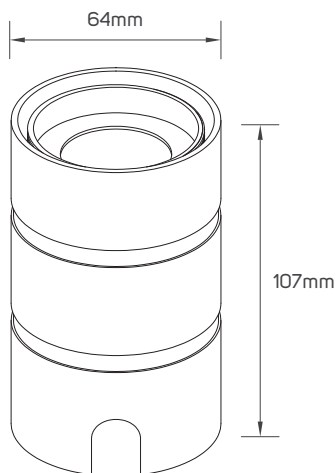

ACCESSORIES SPECIFICATIONS

Code No.	Model No.	Body Color	Body Material
LI615846	ILSCOIGS21	Black	Stainless Steel
LI615847	ILSCOIGW22	Black	Aluminum + Acrylic Glass
LI615848	ILSCOIGW23	Black	Aluminum + Acrylic Glass
LI615849	ILSCOIGW24	Black	Aluminum + Acrylic Glass
LI615850	ILSCOIGW25	Black	Acrylic Glass
LI615851	ILSCOIGW26	Black	Aluminum + Acrylic Glass
LI615852	ILSCOIGW27	Black	Acrylic Glass

ACCESSORIES DIMENSIONS

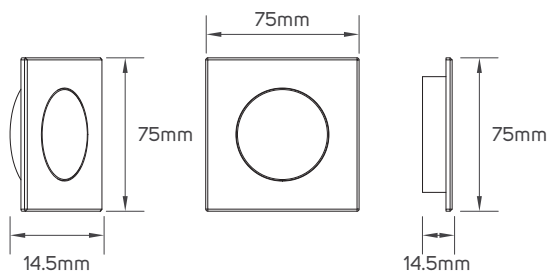

LI615846

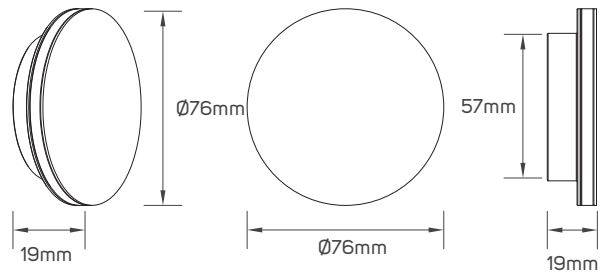

LI615847

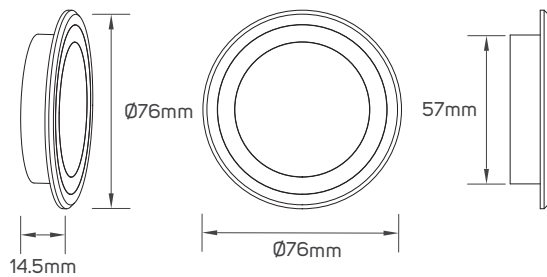

LI615848

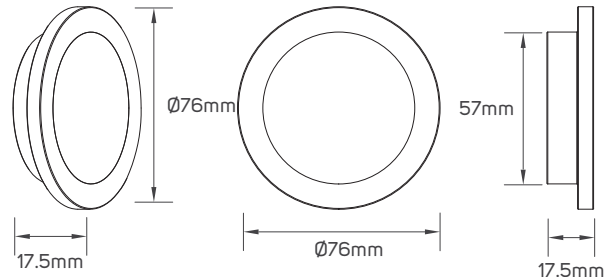

LI615849

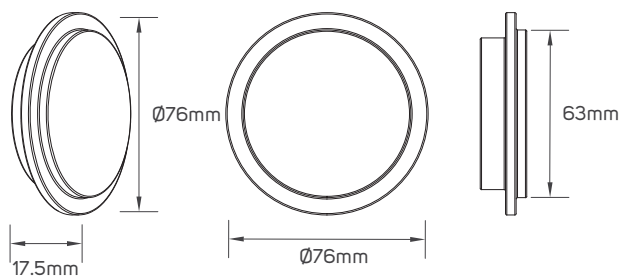

LI615850

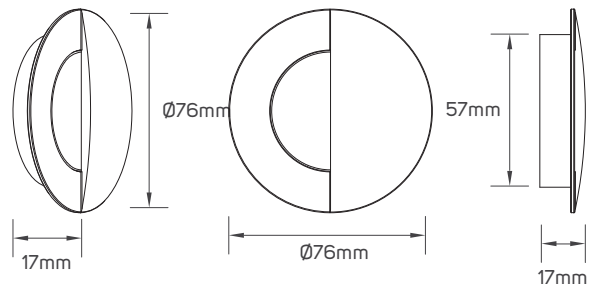

LI615851

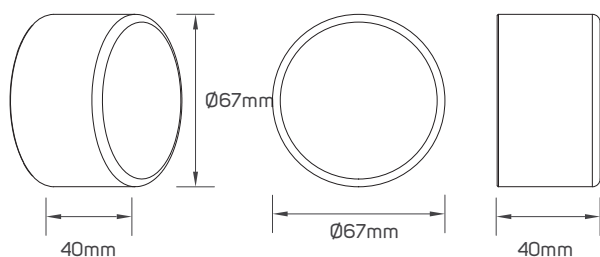

LI615852

APPLICATION PICTURE



This image is for display purpose only, the image may differ from the actual product, as the product is subject to modification provided without prior notice.

LED INGROUND LUMINAIRE

**BEYOND LIGHT..
TO THE LAST DETAILS!**



build-station



lighting stores



illus lighting

C/ Cuenca, 87, Alaquas 46970, (Valencia) Spain, Ph. 34 961 623 958

www.illusillumination.com

illus illumination reserve the right to make dimensional, design and technical alternations without prior notice. illus illumination endeavor to ensure that any advice, recommendation or information it provides in product literature is accurate and correct. However due to the fact that illus do not have direct control on where and how the products are installed, illus illumination cannot accept any liability either direct or indirect arising from the use of illus products whether or not in accordance with any advice, specification, recommendation or information provided by illus illumination or its distributors.